

60V P-Ch Power MOSFET

Feature

- ◇ High Speed Power Switching, Logic Level
- ◇ Enhanced Avalanche Ruggedness
- ◇ 100% UIS Tested, 100% Rg Tested
- ◇ Lead Free, Halogen Free

Application

- ◇ Load Switches
- ◇ Hard Switching and High Speed Circuit
- ◇ BLDC Motor

V_{DS}		-60	V
$R_{DS(on),typ}$	$V_{GS}=-10V$	82	mΩ
$R_{DS(on),typ}$	$V_{GS}=-7V$	120	mΩ
I_D (Silicon Limited)		-10	A

Part Number	Package	Marking
HTD950P06	TO-252	TD950P06

TO-252

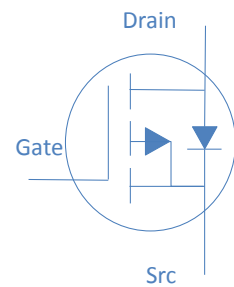
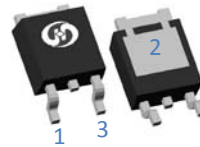

Absolute Maximum Ratings at $T_j=25^\circ\text{C}$ (unless otherwise specified)

Parameter	Symbol	Conditions	Value	Unit
Continuous Drain Current (Silicon Limited)	I_D	$T_C=25^\circ\text{C}$	-10	A
		$T_C=100^\circ\text{C}$	-7	
Drain to Source Voltage	V_{DS}	-	-60	V
Gate to Source Voltage	V_{GS}	-	± 20	V
Pulsed Drain Current	I_{DM}	-	-40	A
Avalanche Energy, Single Pulse	E_{AS}	$L=0.1\text{mH}, T_C=25^\circ\text{C}$	5	mJ
Power Dissipation	P_D	$T_C=25^\circ\text{C}$	27	W
Operating and Storage Temperature	T_J, T_{stg}	-	-55 to 150	$^\circ\text{C}$

Absolute Maximum Ratings

Parameter	Symbol	Max	Unit
Thermal Resistance Junction-Ambient	$R_{\theta JA}$	85	$^\circ\text{C/W}$
Thermal Resistance Junction-Case	$R_{\theta JC}$	4.5	$^\circ\text{C/W}$

Electrical Characteristics at $T_J=25^{\circ}\text{C}$ (unless otherwise specified)
Static Characteristics

Parameter	Symbol	Conditions	Value			Unit
			min	typ	max	
Drain to Source Breakdown Voltage	$V_{(BR)DSS}$	$V_{GS}=0V, I_D=-250\mu A$	-60	-	-	V
Gate Threshold Voltage	$V_{GS(th)}$	$V_{GS}=V_{DS}, I_D=-250\mu A$	-1.0	-1.8	-3.0	
Zero Gate Voltage Drain Current	I_{DSS}	$V_{GS}=0V, V_{DS}=-32V, T_J=25^{\circ}\text{C}$	-	-	-1	μA
		$V_{GS}=0V, V_{DS}=-30V, T_J=125^{\circ}\text{C}$	-	-	-25	
Gate to Source Leakage Current	I_{GSS}	$V_{GS}=\pm 20V, V_{DS}=0V$	-	-	± 100	nA
Drain to Source on Resistance	$R_{DS(on)}$	$V_{GS}=-10V, I_D=-10A$	-	82	95	m Ω
		$V_{GS}=-5V, I_D=-8A$	-	120	140	
Transconductance	g_{fs}	$V_{DS}=-5V, I_D=-10A$	-	9	-	S
Gate Resistance	R_G	$V_{GS}=15mV, V_{DS}=0V, f=1MHz$	-	6.8	-	Ω

Dynamic Characteristics

Input Capacitance	C_{iss}	$V_{GS}=0V, V_{DS}=-25V, f=1MHz$	-	963	-	pF
Output Capacitance	C_{oss}		-	76	-	
Reverse Transfer Capacitance	C_{rss}		-	61	-	
Total Gate Charge	$Q_g(10V)$	$V_{DD}=-30V, I_D=-10A, V_{GS}=-10V$	-	16.2	-	nC
Gate to Source Charge	Q_{gs}		-	2.0	-	
Gate to Drain (Miller) Charge	Q_{gd}		-	3.5	-	
Turn on Delay Time	$t_{d(on)}$	$V_{DD}=-10V, I_D=-1A, V_{GS}=-10V, R_G=6\Omega,$	-	8	-	ns
Rise time	t_r		-	12	-	
Turn off Delay Time	$t_{d(off)}$		-	20	-	
Fall Time	t_f		-	12	-	

Reverse Diode Characteristics

Diode Forward Voltage	V_{SD}	$V_{GS}=0V, I_F=-10A$	-		1.3	V
Reverse Recovery Time	t_{rr}	$I_F=-5A, dI_F/dt=100A/\mu s$	-	12	-	ns
Reverse Recovery Charge	Q_{rr}		-	9	-	nC

Fig 1. Typical Output Characteristics

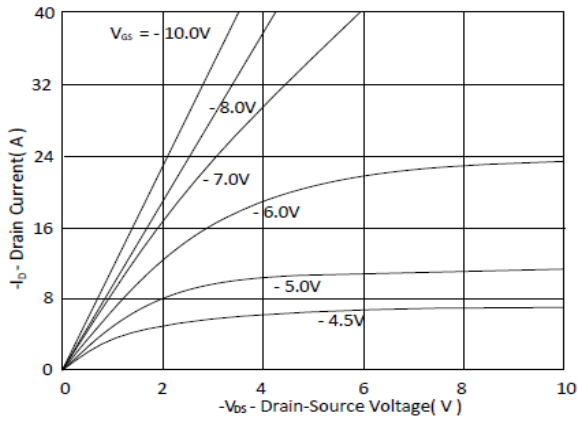

Figure 2. On-Resistance vs. Gate-Source Voltage

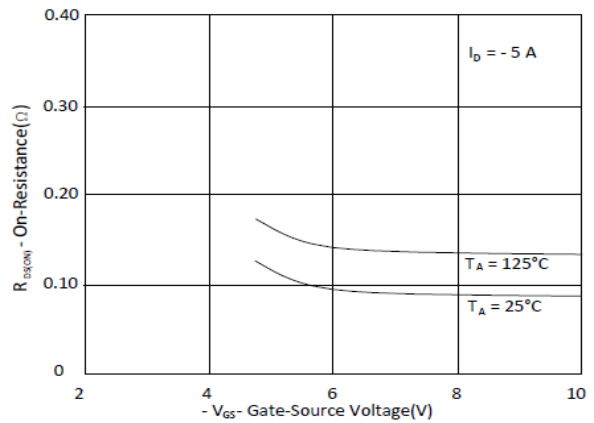

Figure 3. On-Resistance vs. Drain Current and Gate Voltage

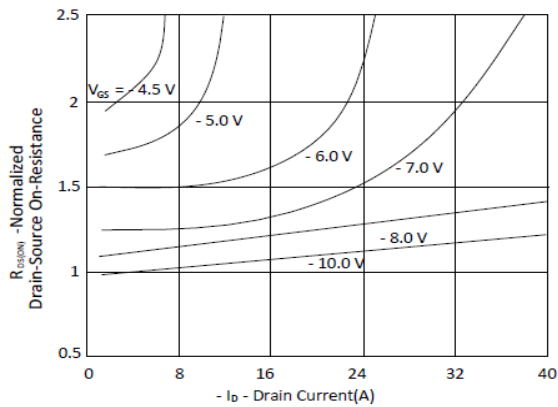

Figure 4. Normalized On-Resistance vs. Junction Temperature

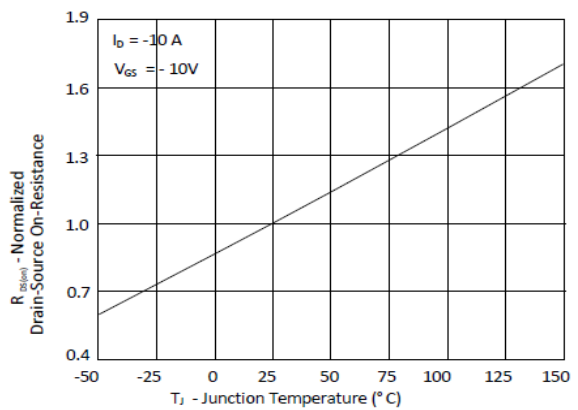

Figure 5. Typical Transfer Characteristics

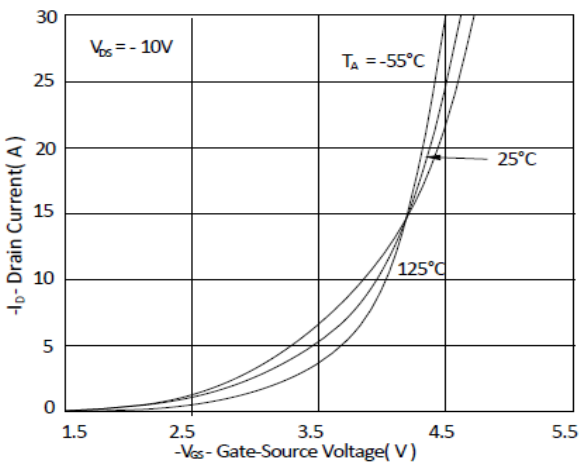

Figure 6. Typical Source-Drain Diode Forward Voltage

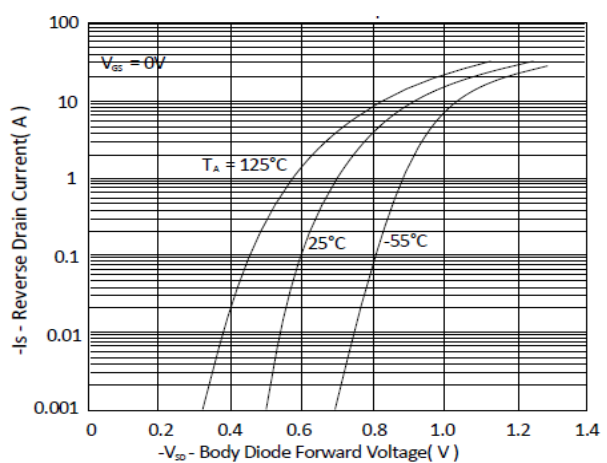

Figure 7. Typical Gate-Charge vs. Gate-to-Source Voltage

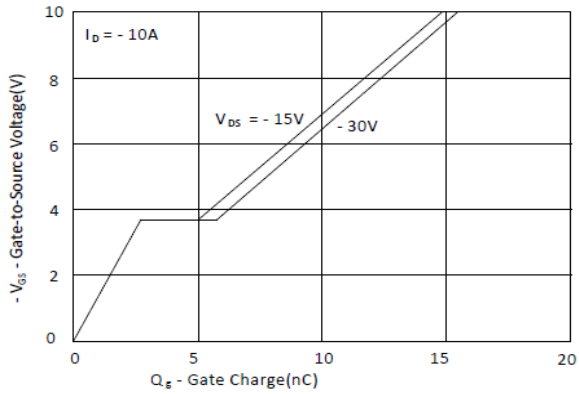

Figure 8. Typical Capacitance vs. Drain-to-Source Voltage

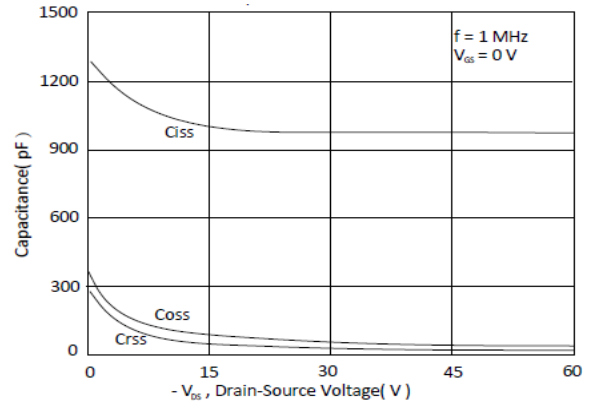

Figure 9. Maximum Safe Operating Area

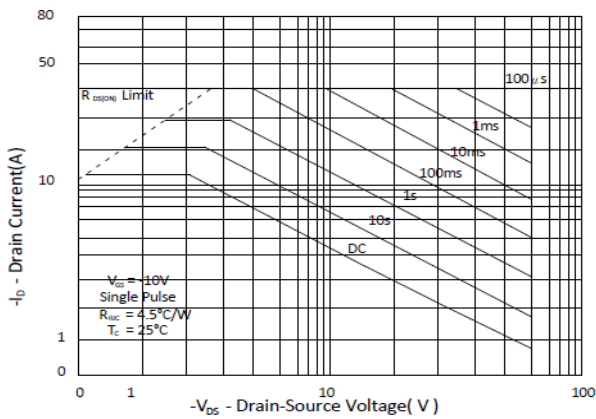

Figure 10. Maximum Drain Current vs. Case Temperature

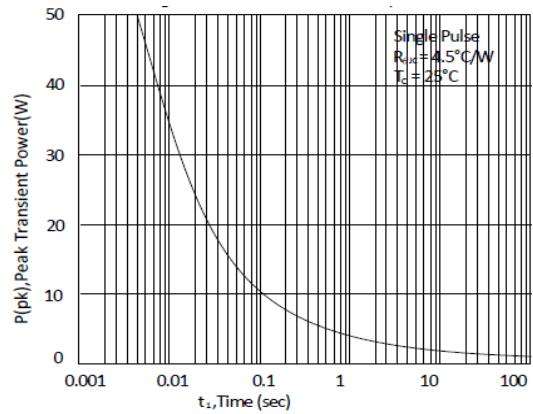
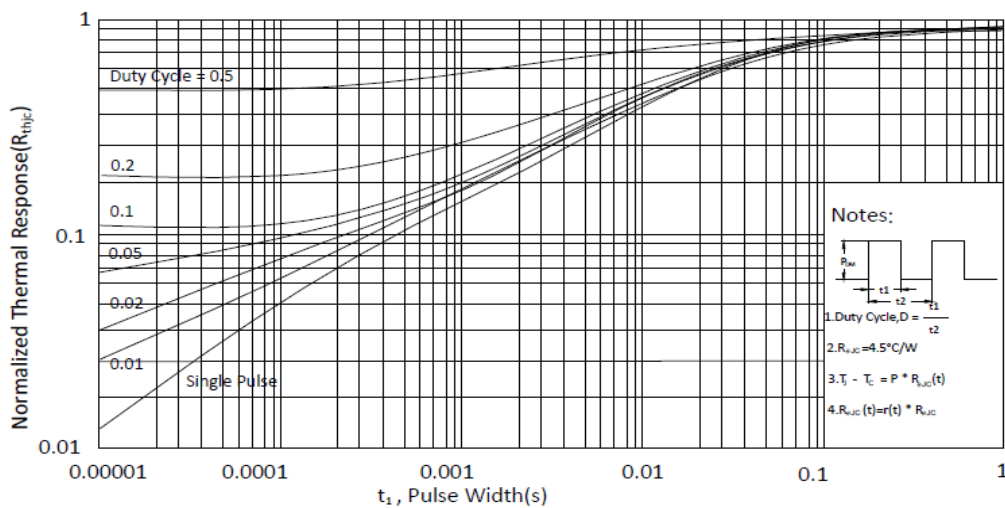
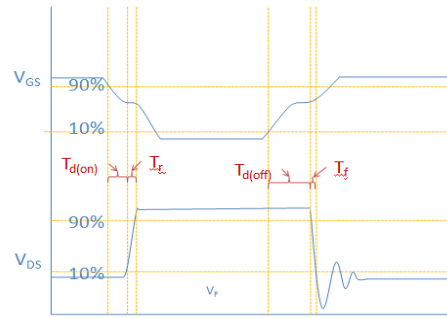
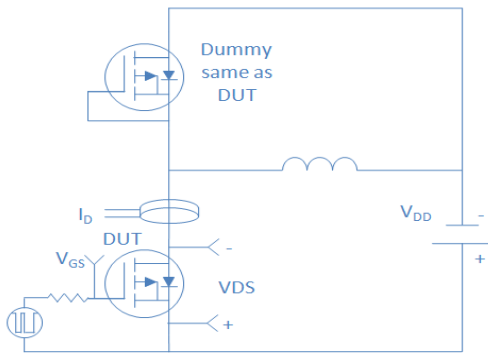

Figure 11. Normalized Maximum Transient Thermal Impedance, Junction-to-Ambient



Inductive switching Test



Gate Charge Test

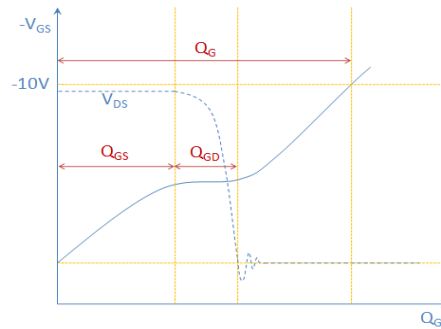
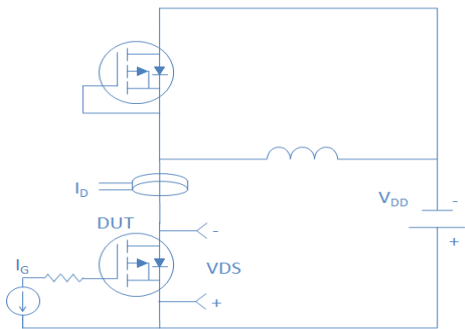

Uclamped Inductive Switching (UIS) Test

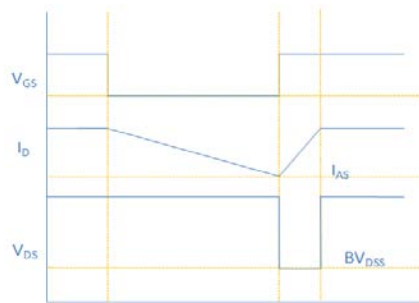
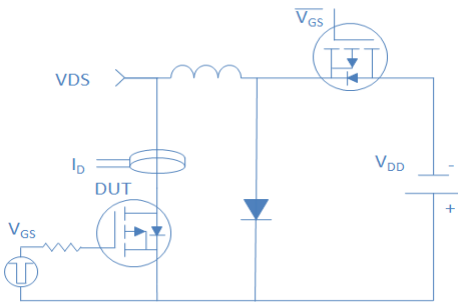

Diode Recovery Test

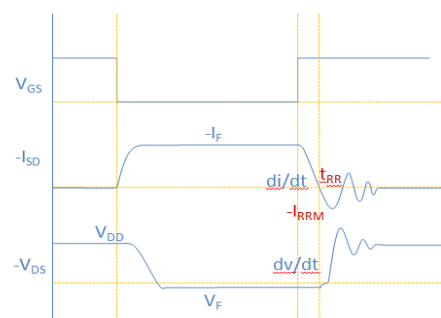
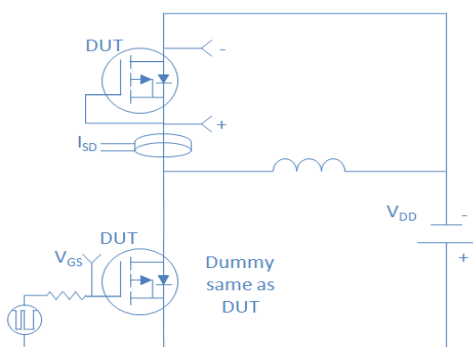

Package Outline

TO-252, 3leads

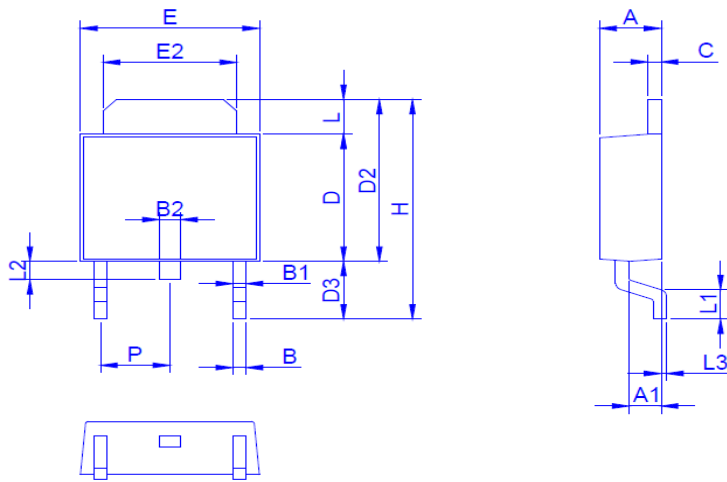

Dimension	A	A1	B	B1	B2	C	D	D2	D3	E	E2	H	L	L1	L2	L3	P
Min.	2.10	0.95	0.30	0.40	0.60	0.40	5.30	6.70	2.20	6.40	4.80	9.20	0.89	0.90	0.50	0.00	2.10
Max.	2.50	1.30	0.85	0.94	1.00	0.60	6.20	7.30	3.00	6.70	5.45	10.15	1.70	1.65	1.10	0.30	2.50